

9XR PRO

TURNIGY 9XR PRO A guide to using the Turnigy 9XR Pro Transmitter



Thank you for choosing the 9XR PRO transmitter. This product's software was produced with help from the Radio Control community and various online forums. Should you have any concerns regarding the functionality or feature set of your radio, please visit forum.turnigy9xr.com or 9xforums.com/forum.

The 9XR PRO is a 9 Channel digital proportional Radio Control transmitter with an inbuilt antenna and the capability of supporting a wide variety of module based TX systems from standard 2.4Ghz DSM2, Long Range Mhz and even frequencies not yet invented! The freedom and choice is yours.

TURNIGY®

9XR Pro: Introduction to the Hardware

A guide to using the Turnigy 9XR Pro Transmitter

Welcome to the Turnigy 9XR Pro and Ersky9x system. We'd like to point out a few things on this radio which are different to other radios and then how to learn more about it and its tremendous capabilities.

Here's what's in this manual:

Which Module?.....	1
Battery Selection.....	1
Battery Related Settings.....	3
Connections.....	5
SD card.....	5
Trainer Port Connections.....	7
Other Possibilities	8
Further Information.....	9
Appendix A: Modifying a FrSky DJT Module for Telemetry.....	10

Which Module?

The 9XR Pro accepts almost any make of transmitter module of the JR shape. If you already have a JR format module and a number of receivers, they will operate perfectly well with the 9XR Pro. Some modules need a little tape to make them a snug fit. Others need to be inserted carefully to avoid bending the pins.

The receivers you use must match the module. To bind the receiver to the transmitter follow the manufacturer's instructions.

You have two main choices of module at this time:

1. FrSky, either DJT or XJT. The DJT supports the older V8 series receivers plus D-series (telemetry) receivers. The XJT supports D-series and V8-II receivers, plus the newer X series receivers.
2. DSM2/DSMX: The OrangeRX module supports both protocols.

In addition, a module using the DSM protocol and providing telemetry is expected soon.

The remarkable capabilities of Ersky9x firmware, including powerful mixing, large model memory, flexible radio setup, voice announcements, haptic feedback, communication with your computer and Eepsyke will be available no matter what brand of module you use.

Battery Selection

The 9XR radios require an input voltage between 6 and 13 volts, allowing use of many different batteries. The main options are outlined below.

The 9XR battery connector is compatible only with a JST plug of the type used for the balance lead on a 3s LiPo/LiFe battery. This means that such a battery can safely be plugged directly into the 9XR. Other types of battery may require fitting a JST-XH 4 pin plug. Only the outer two wires are

used: in the transmitter socket the left pin is negative (black) and the right one is positive (red). Be extremely careful about polarity. Check the polarity of any battery before plugging in.

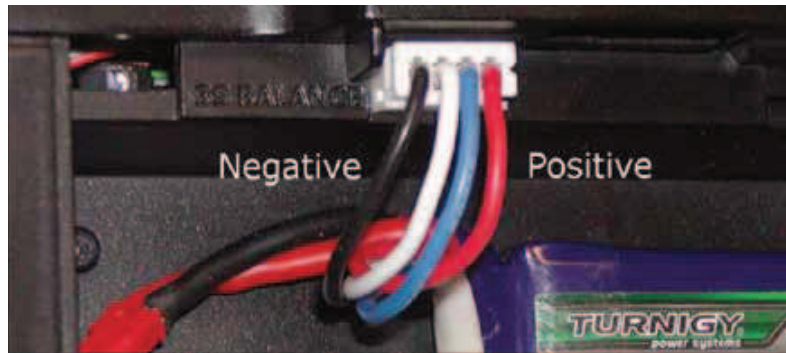

The minimum practical battery capacity is about 800 mAh (milliampere-hour) but batteries in the 1500-2500 mAh range are normally used. These should give at least 10 hours of operation.

The Turnigy 9XR Safety Protected 11.1v (3s) 2200mAh 1.5C Transmitter Pack

This is the battery sold by HobbyKing specifically for the 9XR series of radios. It is a low cost, low discharge rate Lithium Polymer battery which includes a regulator that is claimed to allow it to be charged at a low rate while still in the transmitter. The charger used must deliver less than 0.3 Amps (300 mA) at 12 volts. If the battery is almost fully discharged and a typical 150 mA charger is used, charging may take about 24 hours. The charger jack has the centre pin positive. This is the same as Futaba chargers but opposite JR and Spektrum chargers.

Note that the 9XR radio has a 0.3Amp fuse in the charging circuit to protect the transmitter and battery. This will burn out if subjected to a higher current and is difficult to change.

The battery may be charged outside the transmitter at much higher rates using a proper balancing LiPo charger. The recommended charge rate is 0.5 C, i.e., 1.1 Amps, at which rate a full charge will take about 2 hours. The maximum charge rate is 2.2 Amps.

Even though the battery (unlike other LiPos) can be charged in the transmitter through the charge jack, balance charging out of the transmitter with a proper LiPo charger is strongly recommended.

Because the battery has a low voltage protection circuit that shuts off power to the transmitter at between 9.6 and 10.0 volts, it is very important that the transmitter voltage alarm be set well above that level: a setting of at least 3.6 volts per cell (i.e., 10.8 volts for 3s) is recommended.

“Any Old 3s LiPo”

Any 3S 11.1 volt LiPo battery that will fit into the battery compartment can be used to power the transmitter. Such batteries must be charged out of the transmitter with a proper balancing LiPo charger. At the recommended charge rate of 1C, charging will take about an hour. Note that charging a regular LiPo with a NiMH or NiCd charger will destroy the battery and could start a fire.

To avoid the risk of battery damage or even fire and to ensure that enough energy remains to allow a safe landing, it is recommended that the low voltage alarm be set to at least 3.6 volts per cell (10.8 volts for 3s)

LiFe (Lithium-Iron)

A very inexpensive 3s 1500 mAh LiFe battery specifically for transmitters is available. LiFe batteries are safer than LiPo but still need proper handling. For example, if allowed to discharge fully (by leaving the transmitter turned on) they will be damaged and not be rechargeable in the normal way. Instructions for recovery can be found online but seldom work more than once with a given battery. The typical maximum charge voltage is 10.8 volts, but the battery settles back to 9.9 volts within the first few minutes of use and declines very slowly over the discharge. Of the three leads on the battery, only the balance lead will fit the 9XR. It is recommended to set the low voltage alarm at 9.3 volts. At the recommended rate of 1.5A, charging will take about an hour.

The battery must be charged out of the transmitter with a charger specifically designed for LiFe/A123 type batteries. Charging with a NiMH or NiCd charger will probably destroy the battery.

NiMH

AA-size NiMh cells can be made up into a reliable, safe pack suitable for air travel. Low self-discharge (LSD) should be used. For the 9XR, a six-cell pack is the largest that will fit in the battery compartment. You will need to fit a JST-XH 4 pin balance lead connector (only the outer wires are used). The battery will show about 8.5v immediately after charging and can be discharged to a safe minimum of about 6.6v. Hence such a pack is well within the 9XR voltage limits. The battery may be charged whilst installed in the radio but the charger used must deliver less than 0.3 Amps (300 mA) at 12 volts. If the battery is almost fully discharged and a typical 150 mA charger is used, charging may take up to 24 hours. Higher charging rates may be used with the battery removed from the radio using an intelligent peak-detect charger on the NiMh setting. Refer to the charger manufacturers instructions for the correct method.

It is recommended to set the low voltage alarm to about 7.0 Volts for a 6 cell pack, thus allowing ample headroom for the transmitter regulators and giving the pilot plenty of time to land.

Li-Ion

Packs of two Li-Ion cells may be used in the 9XR transmitter. Cells are available with built in regulators. Capacity varies from 800 to 3200 mAh for the same physical dimensions (the capacity is usually overstated). Typical specifications for an Ultrafire 18650 3200 mAh Rechargeable Battery: Length 67 mm, Diameter 11 mm.

The regulator limits the charge current to 1.5 Amps, so charging time will be around two hours for a near-empty 3200 mAh pack. Care must be taken when soldering leads to the ends of the battery not to apply too much heat so as not to damage the regulator. You will need to fit a JST-XH 4 pin balance lead connector (be super careful to get the polarity right!). These cells require the use of a charger capable of charging Li-Ion cells.

These cells charge to 8.4 volts but quickly assume a consistent delivery at about 7.4 to 7.6 Volts for most of the discharge. The minimum voltage to avoid battery damage is 6.5 Volts, but it is recommended to set the low voltage alarm at 7.0 volts to allow ample headroom for the transmitter regulators (and time to land!).

Battery Related Settings

Calibrating Voltage and Setting the Battery Warning

Before setting the transmitter battery warning you need to calibrate the voltage reading. Measure the voltage of your battery with a voltmeter while the radio is on and then go to the calibration page. A long press of the LEFT key will take you from the home pages to a sequence of eleven radio setup pages. Use LEFT or RIGHT to get to 8/11:



At the bottom of the page opposite A8 is the transmitter voltage reading. Use the DOWN key to scroll down to it. LEFT and RIGHT keys will adjust the voltage to agree with the voltmeter.

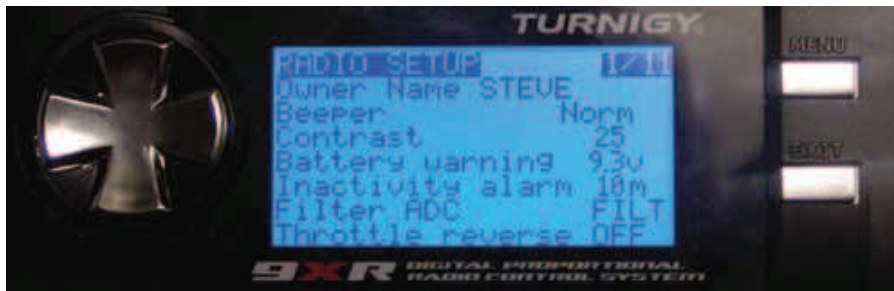

Now set the Battery Warning on page 1/11:

Use UP to go to the top of the page and then LEFT to go to page 1/11. Select Battery Warning. Use the LEFT and RIGHT keys to set the voltage to suit your battery, as recommended above.

Resetting the Battery Capacity Reading

From the home pages a long press of the UP key brings up a page where the battery details, time and a number related to CPU temperature are shown. In particular, the battery capacity used in milliampere-hours (mAh) since last reset is shown:

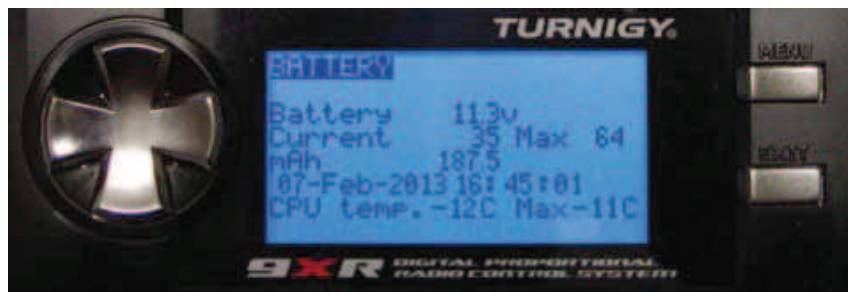

To reset the mAh reading to zero after charging the battery press the MENU key. This will allow you at any time to see how much capacity you have used from the battery since you charged it.

Setting the Capacity Alarm

You may set an alarm to warn you of low remaining battery capacity on the Radio Setup page 2.

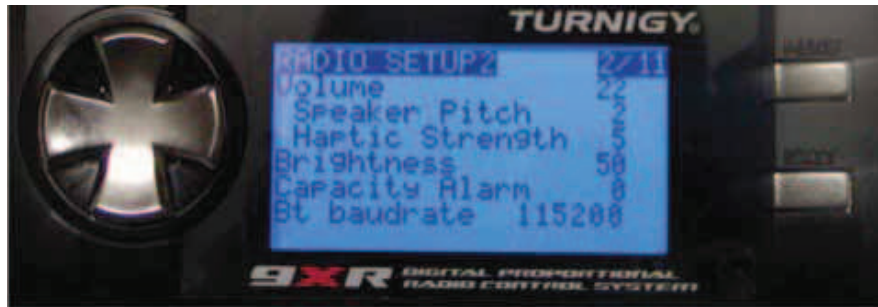

Select a number in mAh that is no more than 80% of the battery capacity. When the battery capacity used reaches this value an alert message will be announced. If the field is left at 0 no alarm will be announced. You have to remember to reset the battery capacity after recharging the battery.

Connections

Under the rubber flap on the bottom right corner are a number of connections.

At the bottom is the Audio headphone connection for an 8 to 32 ohm headset. Next up is the SD card slot. Just above the SD card you can see the mini USB port mounted on its white coloured circuit board. This is used for connecting a cable to a USB port on your computer. It does not provide power to the radio. Above that is the battery charging jack. This is a 2.1 mm jack with the centre positive.

There is a tiny round recessed button on the left of the USB port. DO NOT PUSH THIS BUTTON as doing so will erase the transmitter firmware. If this button has been pressed see the topic “Restoring a ‘Bricked’ Transmitter with SAM-BA” in the manual *Communicating with a Computer*.



SD card

Included with your transmitter is an SD card. This is a micro memory storage card is about the size of a fingernail. It fits into a slot in the lower right corner of your transmitter under the rubber cover, between the headphone jack at the bottom and the mini-USB port in the middle. It is inserted with the gold contacts facing upwards.

It is easier to feel the card than see it when installed. It pushes into place and locks into a detent. To remove it, push it in again and it will be released from the detent.

To read or write to the card with a computer, it can be inserted into a holder which fits a USB port, or it can be slotted into a card reader. The card will then appear on



your computer as a mass storage device and can be opened just like a disk drive. The card can be any size but 2 GB will be large enough for most purposes.

Contents of the Card

There are normally at least four folders in the root directory of the card: Voice, Firmware, Logs and Manuals. The Voice folder contains .wav sound files used for voice announcements by the system. The Firmware folder contains a copy of the Ersky9X operating system firmware for your radio, plus any updated firmware files you may have added in the binary file format with .bin extension. The Logs folder contains any data you may have downloaded from your telemetry sensors in the model in the comma delimited file format, i.e., .csv extension. The manuals folder contains some or all of the manuals listed on the last page of this document.

In addition, individual models can be backed up to the SD card. Highlight the model in the Model Select page, press MENU and choose BACKUP. The resulting .eepm files are stored in a folder called Models. They can be restored to the transmitter by highlighting an empty model slot and pressing MENU. Then select RESTORE and press MENU. Pick which model you wish to use and press MENU again. The models in the SD card can be edited in the Eepskye program.

Flashing Firmware

With the SD card installed in the radio, you can install firmware by turning the radio on while holding the rudder and aileron trim switches towards the centre. To install the firmware select the appropriate file (if there is more than one) and long press MENU. A progress bar will appear. A long EXIT restarts the radio.

The firmware update process uses a “boot loader” that is stored in the transmitter memory. Ersky9X provides a maintenance mode which enables the boot loader to be updated. If the need arises, the update will be provided as part of a normal firmware file, but there will be special instructions telling you to update the boot loader separately. With the SD card installed, enter maintenance mode by holding the aileron and rudder trim keys apart while turning the radio on. Press MENU to see the firmware files, select the appropriate file, and press MENU again to flash the boot loader. Turn the radio off.

Adding Voice and Other Files

To access any of the folders, remove the card from the radio and install it into your USB holder or card reader. Then use your computer to open the appropriate folder. It's a very good idea to copy folders and their files to a back-up folder on the computer for safekeeping. New files downloaded from the web or made by you can now be loaded onto the card. This includes the latest firmware from the developers, which you can find from the Ersky9x sites (the URLs are detailed below) as well as alternate voice files available on line. Model files .eepm can be copied into the Models folder and then uploaded into the radio using the RESTORE function (r202 and later Ersky9x).



Trainer Port Connections

On the top rear side of the radio are trainer cable connection ports for both JR and Futaba cables. The Futaba port is also used for connecting the FrSky telemetry cable from the FrSky DJT module. This cable is not supplied with the radio or module and must be purchased separately.

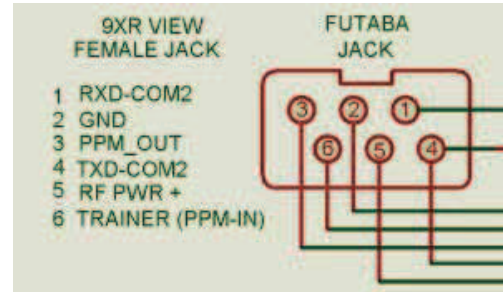
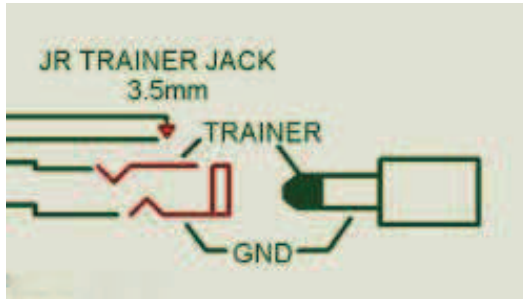

Front View

Telemetry Basics

Telemetry means that values read by sensors in the aircraft can be sent by the receiver back to the transmitter. Signal strength and battery voltage are the most common parameters reported, but a wide range of other possibilities includes GPS coordinates, fuel level, motor temperature, rate of climb/descent, and current.

The signal carrying these data is received by the module and either used to trigger an alarm when necessary or announced over the speaker or headphones (data may also be displayed on-screen, but this is not very helpful to the pilot, whose eyes are on the model). The data may also be logged on the SD card and reviewed later.

FrSky Telemetry

The only telemetry system compatible with the 9XR Pro and with open source firmware such as Ersky9X is currently FrSky. To use this you must have a telemetry-capable FrSky transmitter module (DJT or XJT) and an FrSky telemetry-capable receiver (D-series or X-series).

Relaying the full set of telemetry signals from the FrSky module into the 9XR Pro radio requires a cable that can be purchased to connect the four pin socket on the back of the FrSky DJT and XJT modules to the Futaba Trainer port on the 9XR. Alternatively, a DJT module can be modified internally to avoid the need for a cable (detailed instructions are available in Appendix A).

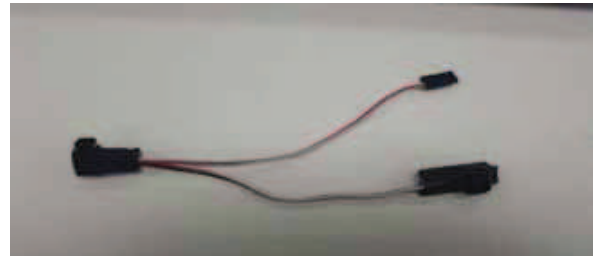

The cable (top) has a second lead to allow a trainer cord to be connected at the same time as the telemetry cable. This may be removed if you don't want it. The photo above above shows a DIY installation.

The DJT module, or an XJT module in D8 mode, when used with a D-series receiver will output all hub sensor data via the serial port.

The display of the received data and its format is determined by what you specify in the telemetry screens in the Model Setup pages. There are two pages, 10/13 and 11/13 where pre-formatted and customisable screens for information can be found.

For a detailed explanation of the various sensors and all other things related to FrSky telemetry, please refer to the FrSky Telemetry Wiki:

http://www.eflightwiki.com/eflightwiki/index.php?title=FrSky_Telemetry

Other Possibilities

Other capabilities of the 9XR Pro hardware when driven by the Ersky9X firmware include:

24 Channels

Older modules such as the FrSky DJT can typically transmit 8 channels, the XJT 16 channels, while later modules will support as many as 24 channels with a compatible receiver. This includes an S-Bus stream that can be used, for example, by helicopter and multirotor flight controllers or compatible servos.

Voice Announcements and Alarms

Any transmitter event can be announced and any alarm or telemetry value spoken (see the manual *Using Voice with Ersky9x*). This can help the pilot keep track of current switch settings and take in information about time or telemetry data.

The 9XR Pro speaker is located on the front of the radio. Its volume can be set in the Radio Set-up pages or control can be assigned to one of the potentiometers. A headphone jack is located under the rubber flap on the bottom of the transmitter. When headphones are used the speaker is silent.

Haptic Feedback

Some alarms and events can be signalled by haptic feedback, meaning that the transmitter vibrates in the pilot's hands. The strength of vibration can be changed in the radio set-up pages.

Telemetry Data Logging

Data from your model may be stored on the SD card. The data files so produced have the name of the model, date and time in the header. They are in comma delimited (.csv) files suitable for loading into a spreadsheet. The data can be analysed, graphed and exported to a word processor.

Further Information

For additional information to help you understand and make best use of your Turnigy 9XR Pro, see the other manuals in this series and/or go to one of the forums dedicated to this transmitter and the open source firmware it uses.

9XR Pro Manuals

The following manuals are designed to help you get the most out of your Turnigy 9XR Pro. They are available at: <http://openrcforums.com/forum/viewforum.php?f=7>

1. 9XR Pro: Introduction to the Hardware
2. 9XR Pro: First Steps with Ersky9x
3. 9XR Pro: Ersky9x Explained
4. 9XR Pro: Communicating with a Computer
5. 9XR Pro: Using Voice with Ersky9x
6. 9XR Pro: Using the Eepskye Program
7. 9XR Pro: Glossary of Terms

Internet Forums

Help is always just a few clicks away on the internet forums where experienced Ersky9x users volunteer their knowledge and experience. Many of these people have been developing the firmware for years without remuneration; all they ask is donations to fund further development.

Open RC Forums: <http://openrcforums.com/forum/index.php>

Ersky9x index page: <http://openrcforums.com/forum/>

9XR index page: <http://openrcforums.com/forum/viewforum.php?f=70>

NOTICE

Ersky9x and Eepskye are free open source software, independently developed. This manual is provided to help you understand and use them specifically for the Turnigy 9XR Pro transmitter, though much of the information also applies to the Sky replacement boards produced as an upgrade for the 9x transmitter.

You can redistribute the software and/or modify it under the terms of the GNU General Public License version 2 as published by the Free Software Foundation. You can also freely quote from, redistribute and/or modify this manual; in doing so please acknowledge the authors, the 9XR Pro Beta Development Team.

The program and the manuals are distributed in the hope that they will be useful, but WITHOUT ANY WARRANTY; without even the implied warranty of MERCHANTABILITY or FITNESS FOR A PARTICULAR PURPOSE. See the GNU General Public License for more details. In using them, you agree that you accept all responsibility.

For more information go to: <http://openrcforums.com/forum/viewforum.php?f=7>

9XR Pro Introduction to the Hardware 2014-03-26.odt

Appendix A: Modifying a FrSky DJT Module for Telemetry

For telemetry data from the model to be conveyed from the module to the 9XR Pro transmitter for display and sounding of warnings, additional connections are required. These can be provided by a cable from the Futaba port on the transmitter to the socket on the DJT module. Alternatively, the module can be modified to eliminate the need for a cable. Doing so will void your manufacturers warranty.

The Turnigy 9XR Pro already has the internal connections needed to accept telemetry signals from the module. The Ersky9x firmware already has the coding needed to display the telemetry data not only from all the FrSky sensors but also from the Winged Shadow How Hi altimeter.

Circuit Diagram:

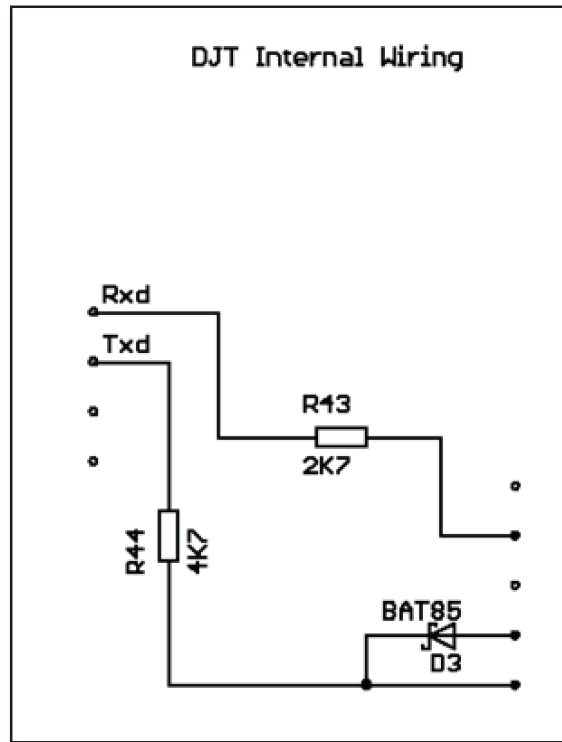

Parts Required

R43: 2,700 Ohm ½ Watt resistor

R44: 4,700 Ohm ½ Watt resistor

D3: BAT85 Schottky Diode (1N5819 Schottky diode may be substituted)

Note: The diode is only required if the module is for use in a Taranis transmitter.

Opening the DJT Module

Undo the screws and release the back cover. It is connected to the circuit board by a short coaxial cable to the base of the antenna. It is possible to complete the modifications without releasing this cable. The small U.FL connector used at the circuit board end has limited life and should not be removed frequently, so it is desirable to leave the antenna cable connected. The circuit board, which lies in the bottom of the plastic box, is retained by detents moulded into each end of the box.

The switches and LED assembly are mounted on the this board too, so that when you remove the board they will be removed with it.

Hold the box lengthwise with both hands, your thumbs on the top edges and fingers pressing underneath the base of the box. Push upwards with your fingers, bending the base of the box upwards and hence pushing the circuit board up. With enough force the circuit board will spring out of the detents at one end. Remove the box.

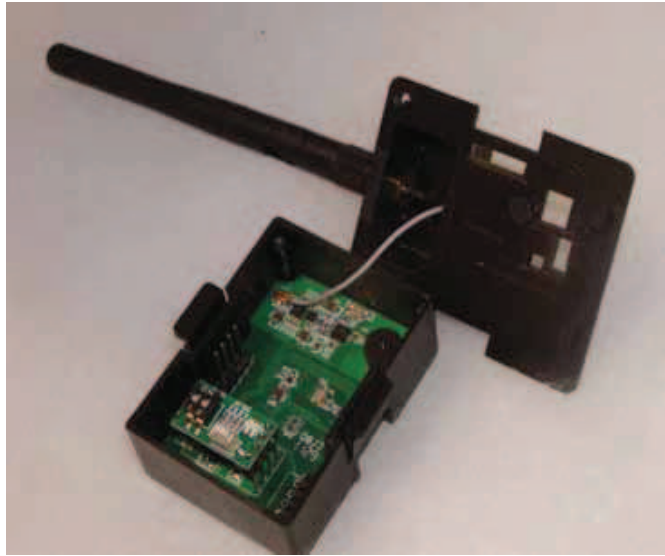

Adding the Components

Orient the circuit board with the switches toward yourself and the top away from you. The board is now oriented the same way as the circuit diagram above. There are four pins at the top left of the board and five sockets on the bottom right.

Solder the 2,700 Ohm resistor between the base of the top left pin and the pad adjacent to the second socket from the top on the right side of the board. Ensure that the end of the resistor is soldered as low as possible on the pin.

Solder the 4,700 Ohm resistor between the base of the second from the top left pin and the pad adjacent to the bottom right socket. (Do not use the adjacent hole with copper trace around it, as this terminal is not connected to the bottom socket.)

If you intend to use this module with a FrSky Taranis (possibly to enable use of older V8 series receivers) you must fit the diode.

The “base” end of the diode is the one with a ring 9n terms of the diode symbol, it's the end with the thick bar at the point of the triangle). Bend back the wire from this end parallel to the body of the diode. Cut the two wires so that the diode can be installed vertically, as shown. Spread the wires apart and solder the short wire to the pad adjacent to the second lowest socket. Bend the longer wire to fit and solder it to the end of the resistor adjacent the lowest socket.

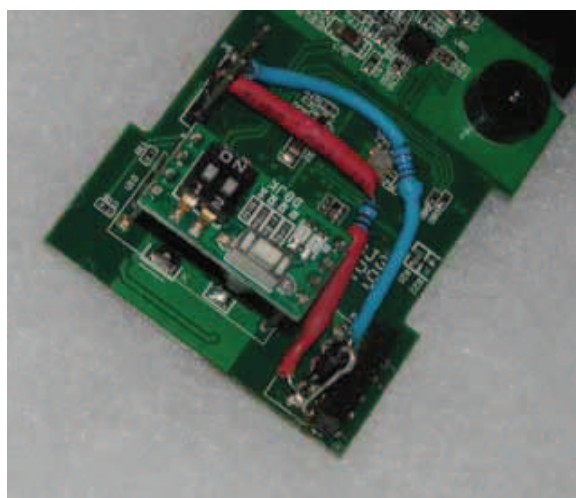
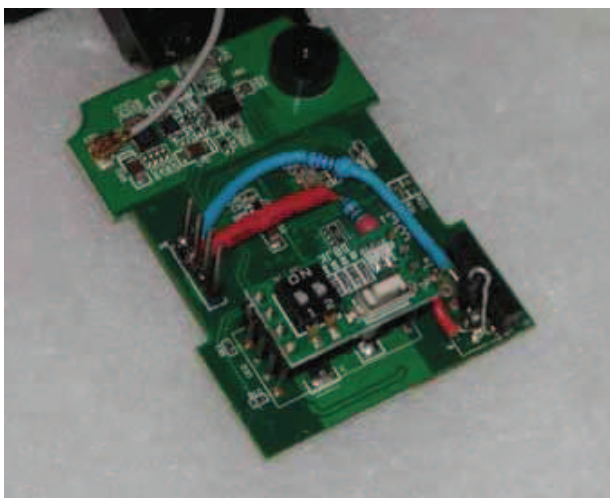

Assembly of the Module

One end of the circuit board has the corners removed to fit the pillars in the box for the back cover screws. Place the circuit board inside the box and carefully push it to the bottom so that it rests parallel with the bottom of the box. Be careful not to apply force to the antenna cable and clip. Using a thumb at each end push the circuit board until it engages the detents.

At the end adjacent to the switches, the cover has tags which slot into the module box. Insert these tags holding the other end at a slight upward angle. Ensure that the switches align with the openings in the cover and close the top end of the cover, making sure the antenna cable is free inside the box. Insert and tighten the screws.

If you have more than one DJT module, mark this one as being modified.

Use of the Module

In addition to the Turnigy 9XR Pro, this module may be used with the FrSky Taranis and the SKY 9x boards. It should NOT be used with the regular Turnigy 9XR or the various 9x transmitters, as the pin connections are not compatible.